



HEATSTRIP®   
Outdoor heating never looked so good





## HEATSTRIP OUTDOOR HEATERS

HEATSTRIP® is a world leader in elegant indoor and outdoor heaters, including wall-mounted patio heaters and electric strip heaters.

HEATSTRIP® provides outdoor heating solutions for some of the best-known venues and beautiful residential homes throughout the World. Find out more about how our award-winning range of heaters can warm up your life.

HEATSTRIP® electric heaters are proudly designed and engineered in Australia and supplied to world markets. HEATSTRIP® heaters are suitable for a wide range of residential, commercial and institutional markets, and are currently available via numerous channels, such large national retailers, independent outdoor living & heating specialists, electrical wholesalers and distributors, both in North America and around the world.

You can be sure that HEATSTRIP® has a product to suit any home or work environment, be it your alfresco area, balcony, patio or bar, club and restaurants.



2017 HEATSTRIP LPG



2013 HEATSTRIP CLASSIC



2014 VICTORIAN MANUFACTURING HALL OF FAME

Thermofilm Australia Pty Ltd

## CLASSIC - PAGE 2

### Application

- Pergola / protected alfresco
- Difficult to heat indoor areas
- Cafe, garage / shed

### Ideal Mounting Height

### Max Mounting Height

2.1 - 2.5m, 7 - 8ft

2.7m, 9ft



## CLASSIC WHITE - PAGE 4

### Application

- Pergola / protected alfresco
- Difficult to heat indoor areas
- Cafe, garage / shed

### Ideal Mounting Height

### Max Mounting Height

2.1 - 2.5m, 7 - 8ft

2.7m, 9ft



## CLASSIC WITH REMOTE & APP - PAGE 6

### Application

- Pergola / protected alfresco
- Difficult to heat indoor areas
- Cafe, garage / shed

### Ideal Mounting Height

### Max Mounting Height

2.1 - 2.5m, 7 - 8ft

2.7m, 9ft



## CLASSIC WITH REMOTE & APP WHITE - PAGE 8

### Application

- Pergola / protected alfresco
- Difficult to heat indoor areas
- Cafe, garage / shed

### Ideal Mounting Height

### Max Mounting Height

2.1 - 2.5m, 7 - 8ft

2.7m, 9ft



## ENHANCE WITH REMOTE & APP - PAGE 10

### Application

- Indoor / Outdoor
- Direct spot heating applications

### Ideal Mounting Height

### Max Mounting Height

2.1 - 2.5m, 7 - 8ft

2.7m, 9ft



## INTENSE WITH REMOTE & APP - PAGE 12

### Application

- Under cover protected areas
- Semi-exposed outdoor locations

### Ideal Mounting Height

### Max Mounting Height

2.1 - 2.5m, 7 - 8ft

2.7m, 9ft



## INTENSE WITH REMOTE & APP WHITE - PAGE 14

### Application

- Under cover protected areas
- Semi-exposed outdoor locations

### Ideal Mounting Height

### Max Mounting Height

2.1 - 2.5m, 7 - 8ft

2.7m, 9ft

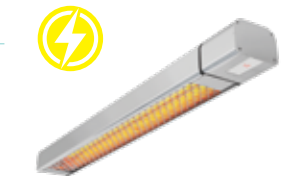

## WALL MOUNTED NATURAL GAS - PAGE 16

### Application

- Alfresco areas / hospitality
- Kitchen / patios / balconies / outdoor dining

### Ideal Mounting Height

### Max Mounting Height

2 - 2.7m, 7 - 8ft

2.7m, 9ft



## PORTABLE LPG - PAGE 18

### Application

- Portable spot heating / hospitality
- Kitchen / patios / balconies / outdoor dining

### Ideal Mounting Height

### Max Mounting Height

2 - 2.7m, 7 - 8ft

2.7m, 9ft



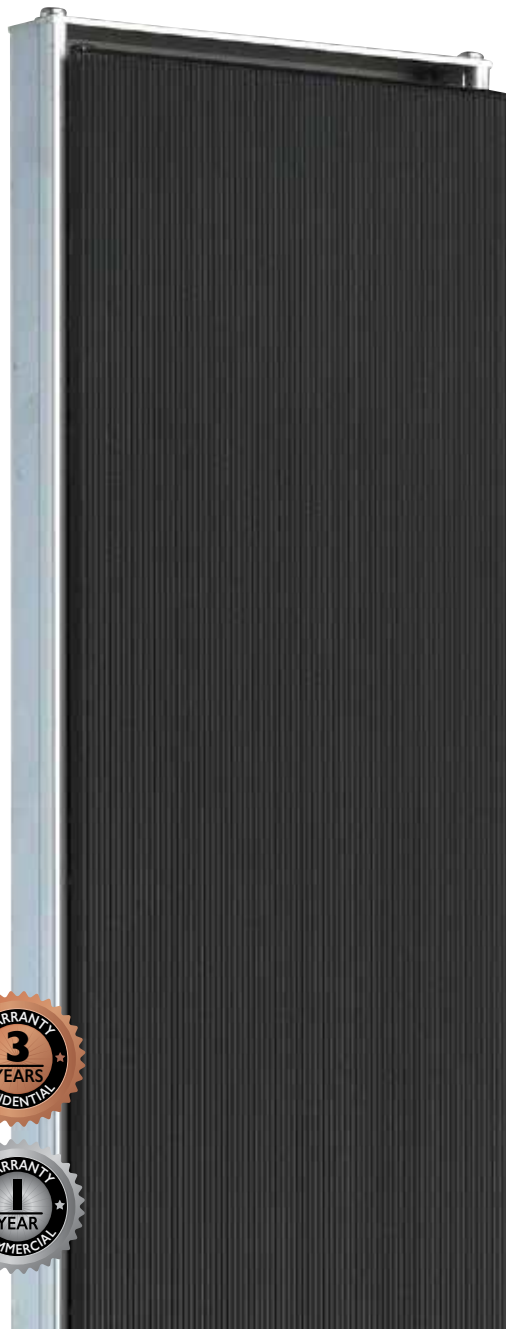

# HEATSTRIP<sup>®</sup> ≡ CLASSIC

SLIMLINE ELECTRIC

**Premium quality, stylish & slimline electric radiant heaters perfect for protected outdoor and indoor applications. Make it a feature in your outdoor area.**

- Electric radiant heater ideal for your protected alfresco area, pergola, veranda, café or difficult to heat indoor areas
- 3 Models available, X-THH2400US-A (2400W) & X-THH3200US-A (3200W)
- Stylish, sleek, unobtrusive design with a black front profile
- Efficient, cost-effective heating providing gentle warmth
- Corrosion protected for even the toughest environment
- Ideal mounting height 2.1-2.5m, 2.1 - 2.5m, 7-8ft
- Max mounting height 2.7m, 9ft
- 3-year residential and 1-year commercial warranty.

## Remote & App



Stylish, sleek, unobtrusive design with unique HEATSTRIP front profile and coating technology.

## Optional mounting accessories



Flush Mount Enclosure is an ideal way to neatly install the Heater into a ceiling.



Extension Mount Poles allow units to be lowered from high ceilings.



Standard Mounting Bracket ZBRAK-113S included with the heater.



## Specifications

Model	Voltage (V)	Power (Watts)	Current (Amps)	Dimensions	Weight	Gang Box	Heating Area	Standard Bracket	Flush Mount Kit	Extension Poles
X-THH2400US-A	240	2400	10	1364x165x48mm 53.7x6.5x1.9in	7kg 15lb	Yes	4-5 m <sup>2</sup> 43-54ft <sup>2</sup>	ZBRAK-113S	THHAC-011	THHAC-005 (300mm 11.8in) THHAC-006 (600mm 23.6in)
X-THH3200US-A	240	3200	13.3	1774x165x48mm 69.8x6.5x1.9in	9kg 20lb	Yes	5-6 m <sup>2</sup> 54-65ft <sup>2</sup>	ZBRAK-113S	THHAC-012	THHAC-007 (900mm 35.4in) THHAC-008 (1200mm 47.2in)

## Coverage

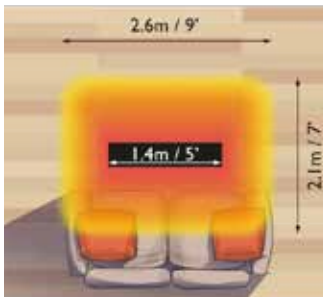

X-THH2400US-A  
Indoor direct overhead mounting

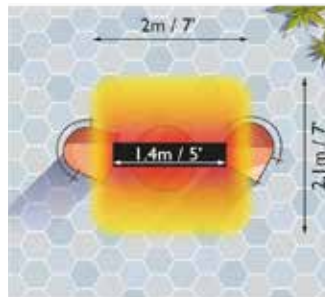

X-THH2400US-A  
Outdoor enclosed

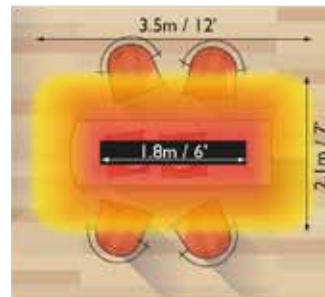

X-THH3200US-A  
Indoor direct overhead mounting

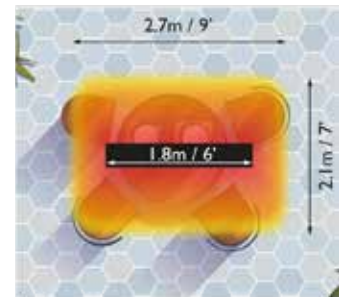

X-THH3200US-A  
Outdoor enclosed

## Mounting options

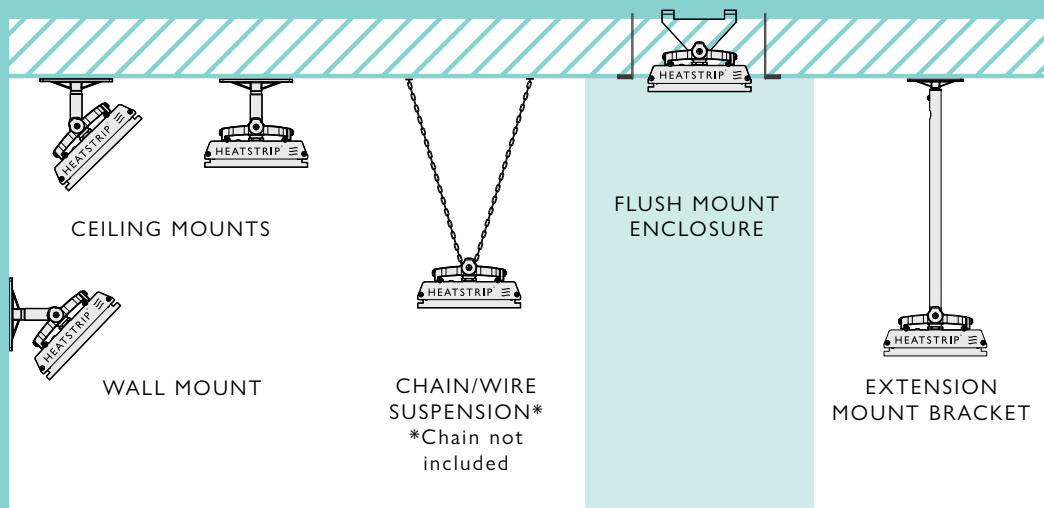

## Flush mount detail

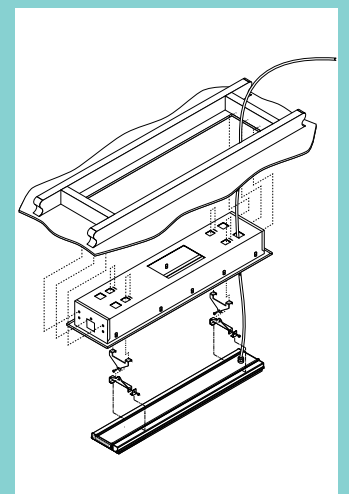

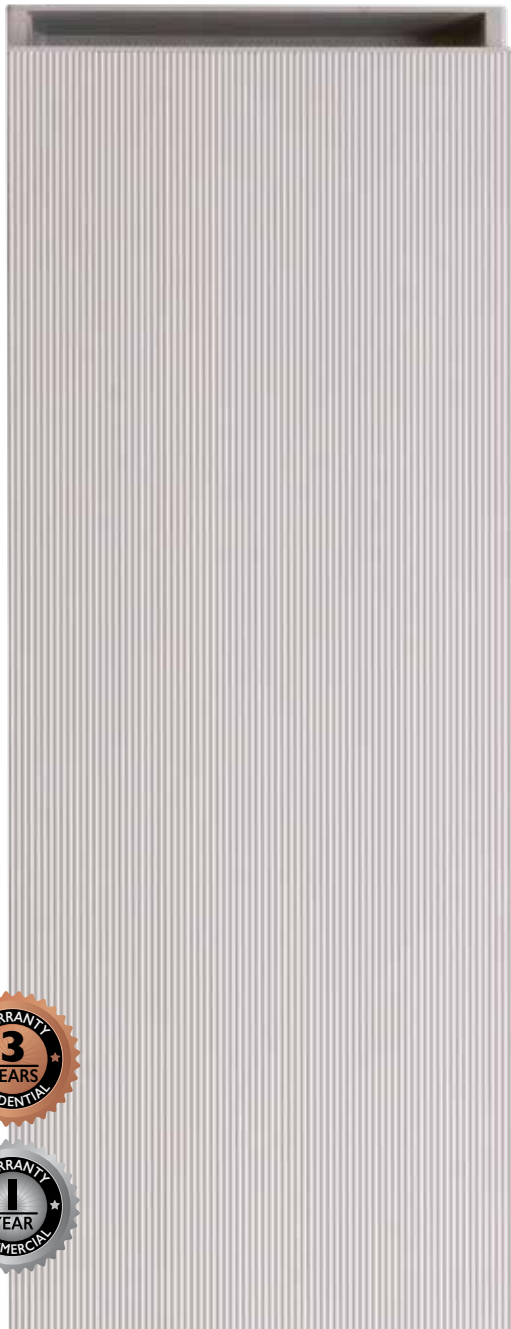

# HEATSTRIP® ≡ CLASSIC

SLIMLINE ELECTRIC

**With superior technology and understated elegance, the HEATSTRIP® Classic White stands as the premier heating solution for any stylish outdoor area. Its modern design and unique “off-white” color effortlessly complement the white ceiling of your patio.**

- Electric radiant heater perfect for your protected alfresco area, pergola, verandah, café or difficult to heat indoor area.
- 2 Models available X-THH2400US-AW (2400W), X-THH3200US-AW (3200W).
- Stylish, sleek, unobtrusive design with a unique “off-white” colour.
- Efficient, cost-effective heating providing gentle warmth.
- Corrosion-resistant to handle tough outdoor environments.
- Ideal mounting height: 2.1 – 2.5m, 7-8ft
- Max mounting height : 2.7m, 9ft
- 3-year residential and 1-year commercial warranty.

## Remote & App



Stylish, sleek, unobtrusive design with unique HEATSTRIP front profile and coating technology.

## Optional mounting accessories



Flush Mount Enclosure is an ideal way to neatly install the Heater into a ceiling.



Extension Mount Poles allow units to be lowered from high ceilings.



Standard Mounting Bracket ZBRAK-113W included with the heater.



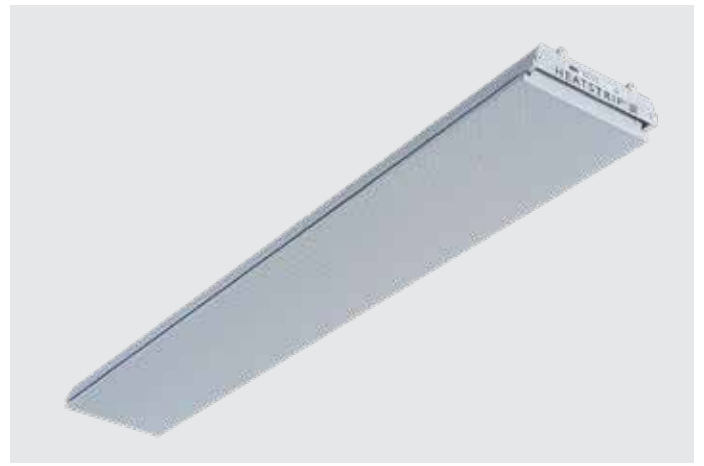

## Specifications

Model	Voltage (V)	Power (Watts)	Current (Amps)	Dimensions	Weight	Gang Box	Heating Area	Standard Bracket	Flush Mount Kit	Extension Poles
X-THH2400US-AW	240	2400	10	1364x165x48mm 53.7x6.5x1.9in	7kg 15lb	Yes	4-5 m <sup>2</sup> 43-54ft <sup>2</sup>	ZBRAK-113W	THHAC-011	THEAC-043 (300mm 11.8in) THEAC-044 (600mm 23.6in) THEAC-045 (900mm 35.4in) THEAC-046 (1200mm 47.2in)
X-THH3200US-AW	240	3200	13.3	1774x165x48mm 69.8x6.5x1.9in	9kg 20lb	Yes	5-6 m <sup>2</sup> 54-65ft <sup>2</sup>	ZBRAK-113W	THHAC-012	

## Coverage

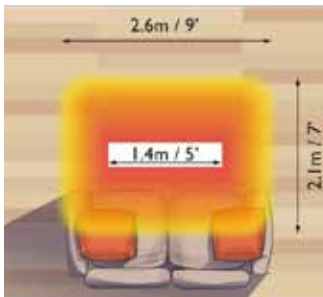

X-THH2400US-AW  
Indoor direct overhead mounting

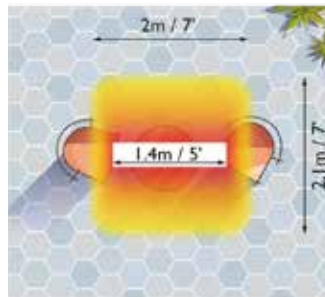

X-THH2400US-AW  
Outdoor enclosed

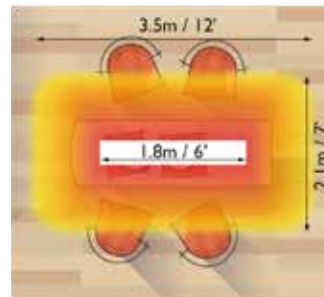

X-THH3200US-AW  
Indoor direct overhead mounting

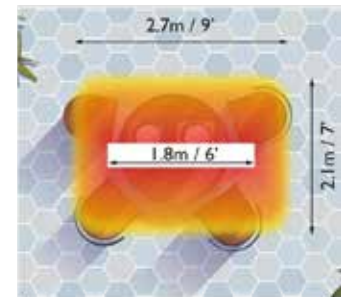

X-THH3200US-AW  
Outdoor enclosed

## Mounting options

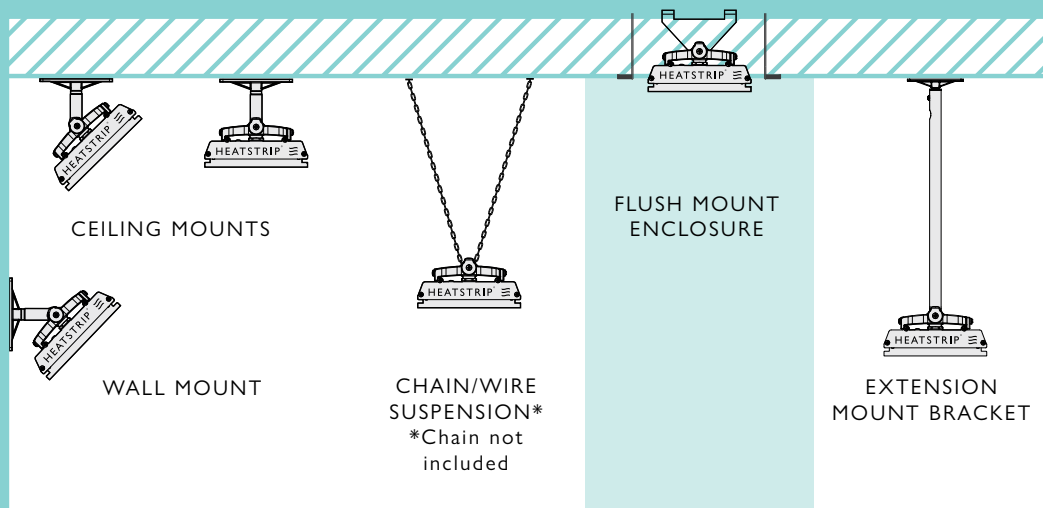

## Flush mount detail

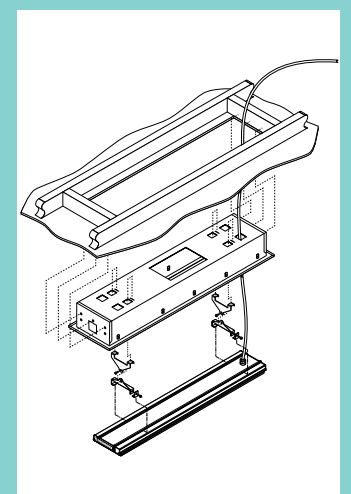



## HEATSTRIP<sup>®</sup> ≡ CLASSIC

WITH REMOTE & APP

**App and remote controlled sleek, all-black electric heating solution for your undercover, protected alfresco area, balcony, patio, porch or verandah. Also suitable for indoor use.**

- Indoor/Outdoor electric radiant heater
- 2 Models available X-THH2400-AA (2400W) & X-THH3200-AA (3200W)
- Remote, app plus smart home connectivity. Compatible with Google and Amazon smart home platforms. Bluetooth & WIFI
- Standard mounting bracket can be used for wall or ceiling mounting. Bracket can also be used to suspend the heater using chains or wires
- Ideal mounting height 2.1-2.5m, 7-8ft
- Max mounting height 2.7m, 9ft
- 3-year residential and 1-year commercial warranty.

### Remote & App



App and remote control provides 3 heat levels with adjustable timer options from 0-24 hours with the touch of a button.

### Optional mounting accessories



Flush Mount Enclosure is an ideal way to neatly install the Heater into a ceiling.



Extension Mount Poles allow units to be lowered from high ceilings.



Standard Mounting Bracket ZBRAK-113B included with the heater.





## Specifications

Model	Voltage (V)	Power (Watts)	Current (Amps)	Dimensions	Weight	Gang Box	Heating Area	Standard Bracket	Flush Mount Kit	Extension Poles
X-THH2400-AA	240	2400	10	1371x165x48mm 54x6.5x1.9in	7kg 15lb	Yes	4-5 m <sup>2</sup> 43-54ft <sup>2</sup>	ZBRAK-113B	THHAC-013	THYAC-047 (300mm 11.8in) THYAC-048 (600mm 23.6in) THYAC-049 (900mm 35.4in) THYAC-050 (1200mm 47.2in)
X-THH3200-AA	240	3200	13.3	1780x165x48mm 70x6.5x1.9in	9kg 20lb	Yes	5-6 m <sup>2</sup> 54-65ft <sup>2</sup>	ZBRAK-113B	THHAC-014	

## Coverage

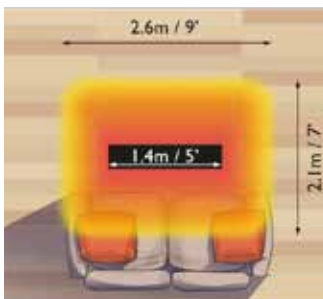

X-THH2400-AA  
Indoor direct overhead mounting

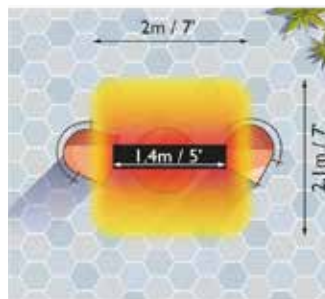

X-THH2400-AA  
Outdoor enclosed

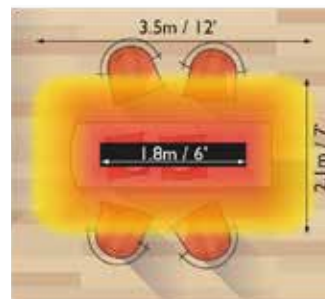

X-THH3200-AA  
Indoor direct overhead mounting

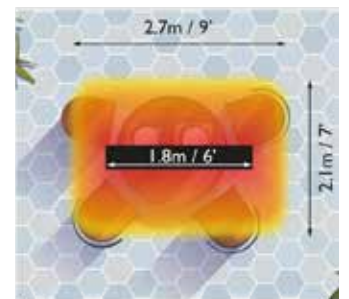

X-THH3200-AA  
Outdoor enclosed

## Mounting options

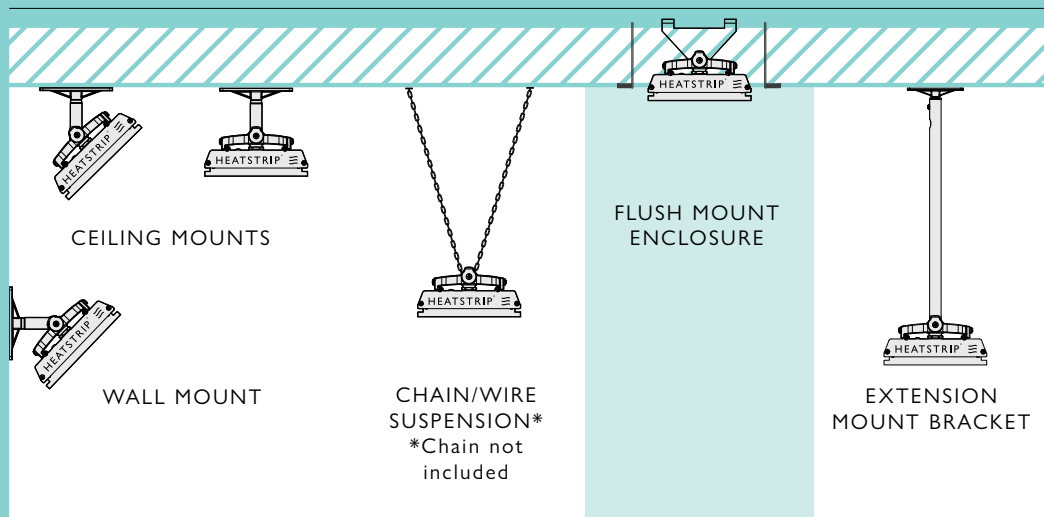

## Flush mount detail

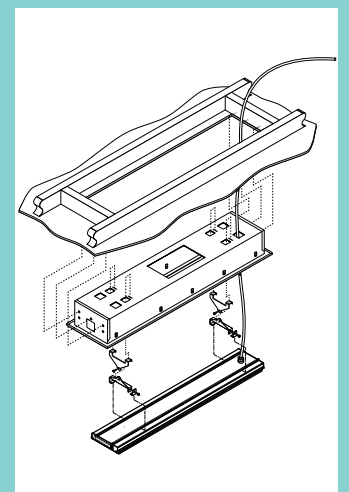

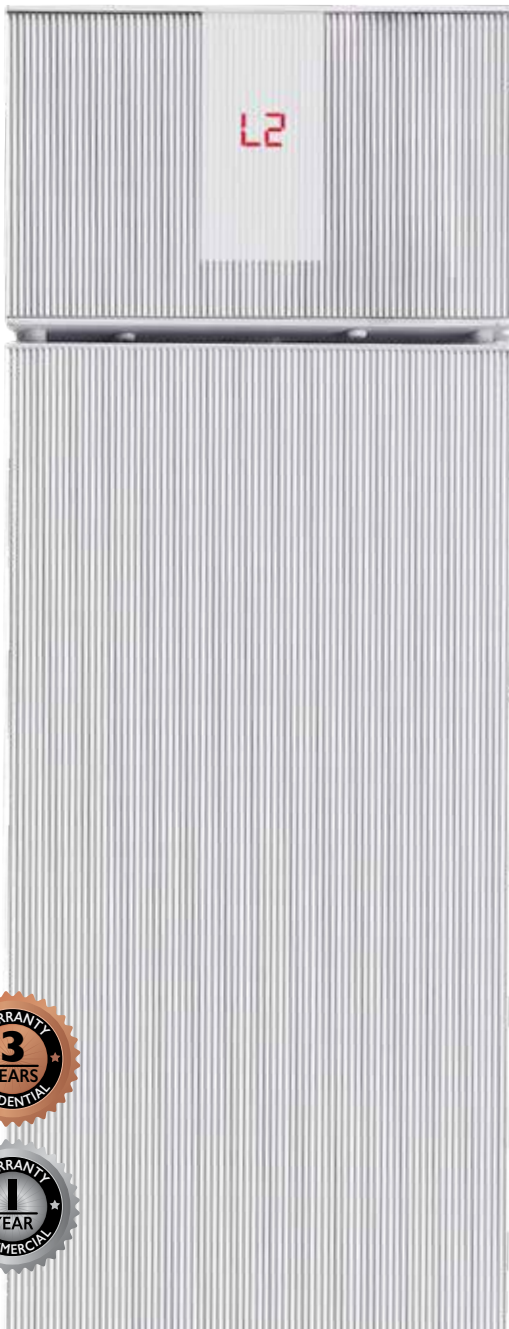

## HEATSTRIP<sup>®</sup> ≡ CLASSIC

WITH REMOTE & APP

**App and remote controlled sleek, unique “off-white” electric heating solution for your undercover, protected alfresco area, balcony, patio, porch or verandah. Also suitable for indoor use.**

- Indoor/Outdoor electric radiant heater
- 2 Models available X-THH2400-AAW (2400W) & X-THH3200-AAW (3200W)
- Remote, app plus smart home connectivity. Compatible with Google and Amazon smart home platforms. Bluetooth & WIFI
- Standard mounting bracket can be used for wall or ceiling mounting. Bracket can also be used to suspend the heater using chains or wires
- Ideal mounting height 2.1-2.5m, 7-8ft
- Max mounting height 2.7m, 9ft
- 3-year residential and 1-year commercial warranty.

### Remote & App



App and remote control provides 3 heat levels with adjustable timer options from 0-24 hours with the touch of a button.

### Optional mounting accessories



Flush Mount Enclosure is an ideal way to neatly install the Heater into a ceiling.



Extension Mount Poles allow units to be lowered from high ceilings.



Standard Mounting Bracket ZBRAK-113W included with the heater.

**Materials of construction:** High temperature ceramic coated extruded alloy. IP55 Rated. Voltage Nominal at 50 - 60 Hertz, Single Phase.



## Specifications

Model	Voltage (V)	Power (Watts)	Current (Amps)	Dimensions	Weight	Gang Box	Heating Area	Standard Bracket	Flush Mount Kit	Extension Poles
X-THH2400-AAW	240	2400	10	1371x165x48mm 54x6.5x1.9in	7kg 15lb	Yes	4-5 m <sup>2</sup> 43-54ft <sup>2</sup>	ZBRAK-113W	THHAC-013	THEAC-043 (300mm 11.8in) THEAC-044 (600mm 23.6in) THEAC-045 (900mm 35.4in) THEAC-046 (1200mm 47.2in)
X-THH3200-AAW	240	3200	13.3	1780x165x48mm 70x6.5x1.9in	9kg 20lb	Yes	5-6 m <sup>2</sup> 54-65ft <sup>2</sup>	ZBRAK-113W	THHAC-014	

## Coverage

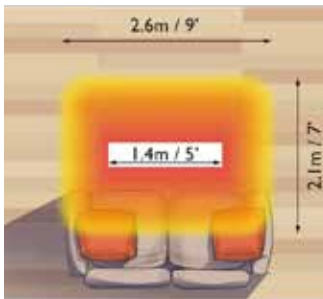

X-THH2400-AAW  
Indoor direct overhead mounting

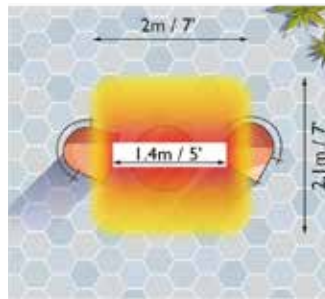

X-THH2400-AAW  
Outdoor enclosed

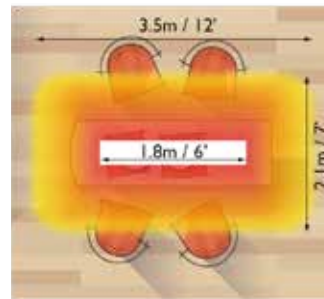

X-THH3200-AAW  
Indoor direct overhead mounting

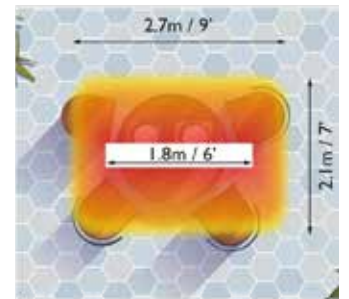

X-THH3200-AAW  
Outdoor enclosed

## Mounting options

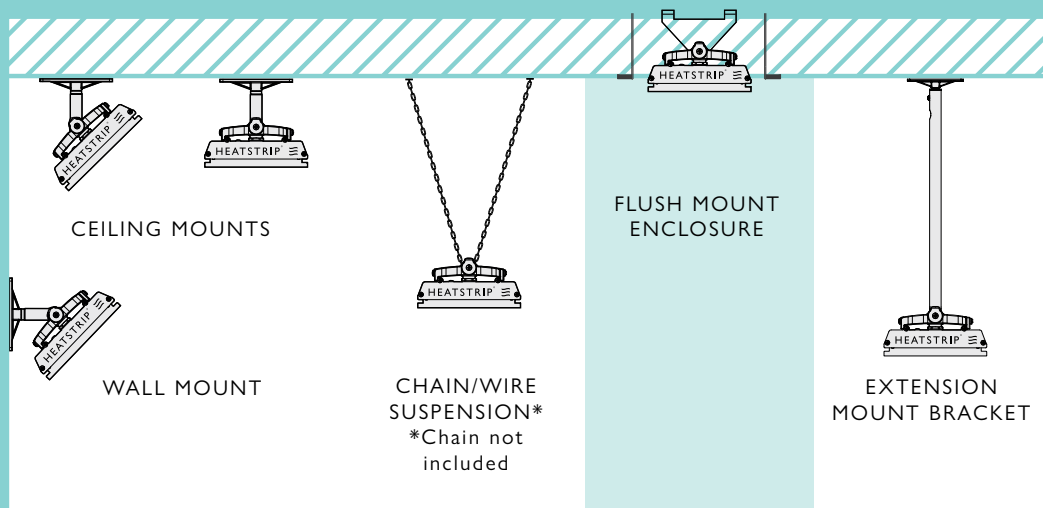

## Flush mount detail

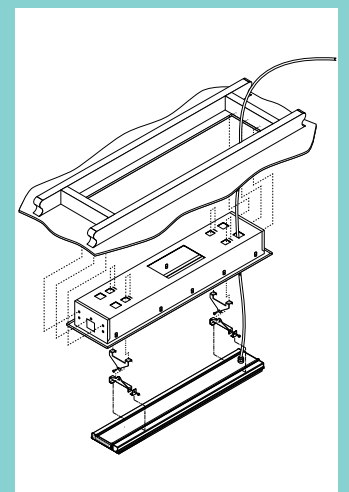



## HEATSTRIP® ENHANCE

WITH REMOTE & APP

This slimline heater with a sleek German Schott glass front is the perfect all-black electric heating solution for instant performance. Easily control the heater with the included remote and app, with a timer ranging from 0-24 hours and 3 different heating levels. Whether you need localised or direct spot heating indoors or outdoors, this heater is sure to meet your needs.

- Indoor/outdoor electric radiant heater.
- 2 models available X-THG2400BA (2400 Watt) and X-THG3200BA (3200 Watt)
- Remote, app plus smart home connectivity. Compatible with Google and Amazon smart home platforms. Bluetooth & WIFI
- Remote control provides 3 heat levels with adjustable timer options from 0-24 hours with the touch of a button.
- Ideal Mounting Height: 2.1 – 2.5m, 7-8ft.
- Max Mounting Height : 2.7m, 9ft.
- 3-year residential and 1-year commercial warranty.

### Remote & App



With remote, App control & smart home connectivity Bluetooth & Wifi.

### Optional mounting accessories



THGAC-001. Flush Mount Kit for X-THG2400BA



THGAC-001. Flush Mount Kit for X-THG3200BA



Standard mounting bracket ZBRAK-154 included can be used for wall or ceiling mounting. Bracket can also be used to suspend the heater using chains or wires.





## Specifications

Model	Voltage (V)	Power (Watts)	Current (Amps)	Dimensions	Weight	Gang Box	Heating Area	Standard Bracket	Flush Mount Kit
X-THG2400BA	240	2400	10	920x187x76mm 36.2x7.4x3in	9kg 20lb	Yes	6-8 m <sup>2</sup> 65-86ft <sup>2</sup>	ZBRAK-154	THGAC-001
X-THG3200BA	240	3200	13.3	1020x187x76mm 40x7.4x3in	10kg 22lb	Yes	8-10 m <sup>2</sup> 86-129ft <sup>2</sup>	ZBRAK-154	THGAC-002

## Coverage

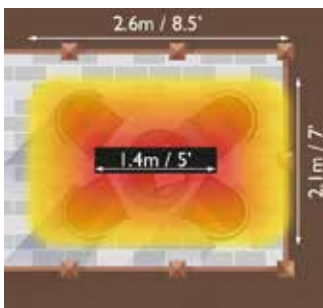

X-THG2400BA  
Outdoor enclosed

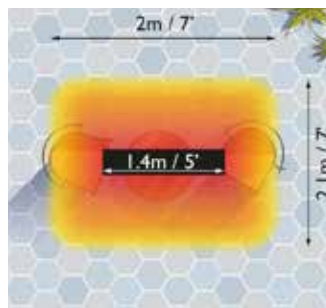

X-THG2400BA  
Outdoor exposed

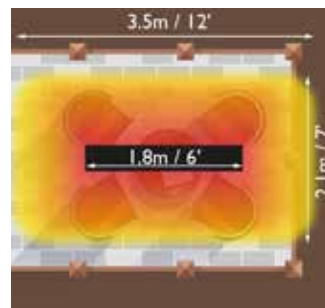

X-THG3200BA  
Outdoor enclosed

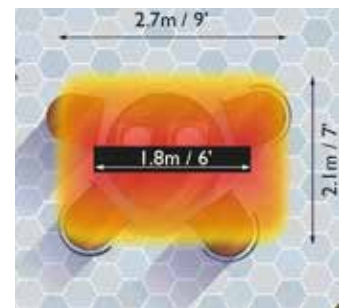

X-THG3200BA  
Outdoor exposed

## Mounting options

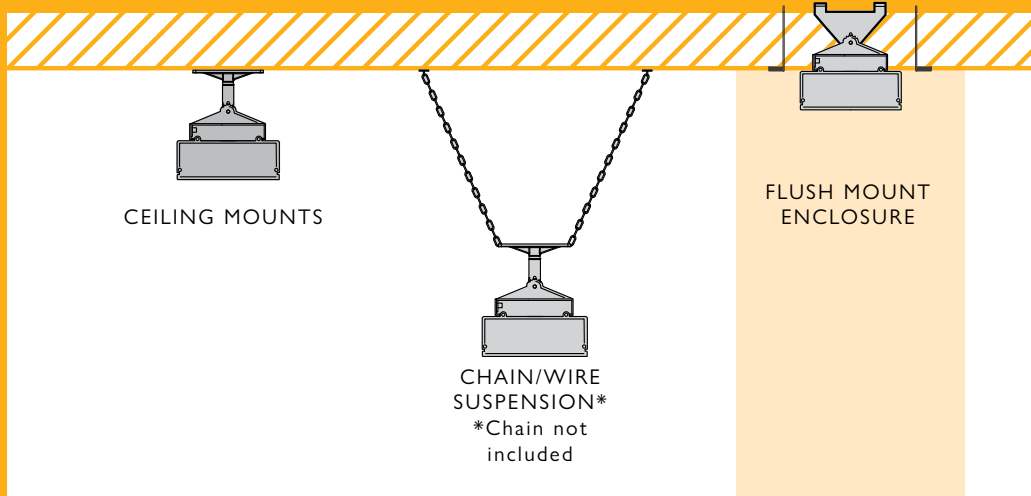

## Flush mount detail

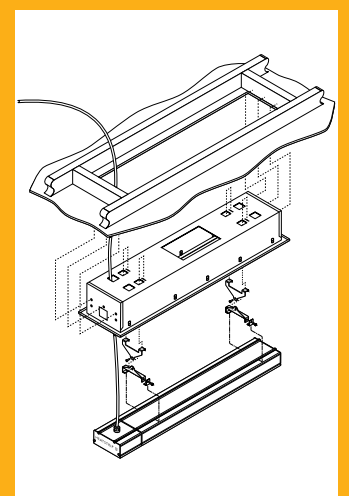



## HEATSTRIP® INTENSE

WITH REMOTE & APP

This sleek, all-black electric heating system provides a modern and attractive outdoor heating solution with high output and instant heat. Perfect for undercover and semi-exposed outdoor areas or indoor use, you can control it with an app or remote for added convenience.

- Indoor/outdoor electric radiant heater.
- 2 models available X-THB2200BA (2200W) & X-THB3200BA (3200W).
- Remote, APP plus smart home connectivity. Compatible with Google and Amazon smart home platforms. Bluetooth & WIFI.
- Standard mounting bracket can be used for wall or ceiling mounting. Bracket can also be used to suspend the heater using chains or wires.
- Ideal Mounting Height: 2.1 – 2.5m, 7-8ft.
- Max mounting height 2.7m, 9ft.
- 3-year residential and 1-year commercial warranty.

### Remote & App



App and remote control provides 3 heat levels with adjustable timer options from 0-24 hours with the touch of a button

### Optional mounting accessories



Flush Mount Enclosure is an ideal way to neatly install the Heater into a ceiling.



Extension Mount Poles allow units to be lowered from high ceilings.



Standard Mounting Bracket ZBRAK-132B included with the heater.



## Specifications

Model	Voltage (V)	Power (Watts)	Current (Amps)	Dimensions	Weight	Gang Box	Heating Area	Standard Bracket	Flush Mount Kit	Extension Poles
X-THB2200BA	240	2200	9.2	900x122x90mm 35.4x4.8x3.5in	6kg 13lb	Yes	5-9 m <sup>2</sup> 54-97ft <sup>2</sup>	ZBRAK-132B	THBAC-001	THYAC-047 (300mm 11.8in) THYAC-048 (600mm 23.6in) THYAC-049 (900mm 35.4in) THYAC-050 (1200mm 47.2in)
X-THB3200BA	240	3200	13.3	1040x122x90mm 41x4.8x3.5in	7kg 15lb	Yes	8-13 m <sup>2</sup> 86-140ft <sup>2</sup>	ZBRAK-132B	THYAC-051	

## Coverage

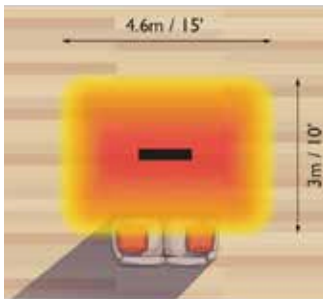

X-THB2200BA  
Indoor protected

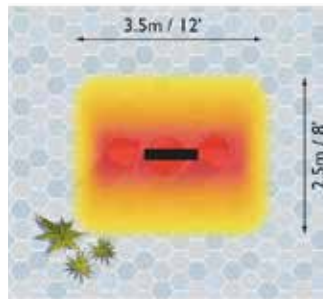

X-THB2200BA  
Outdoor enclosed

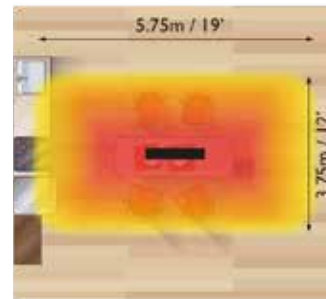

X-THB3200BA  
Indoor protected

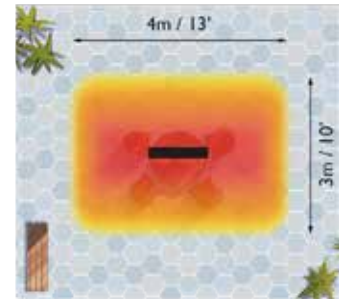

X-THB3200BA  
Outdoor enclosed

## Mounting options



## Flush mount detail

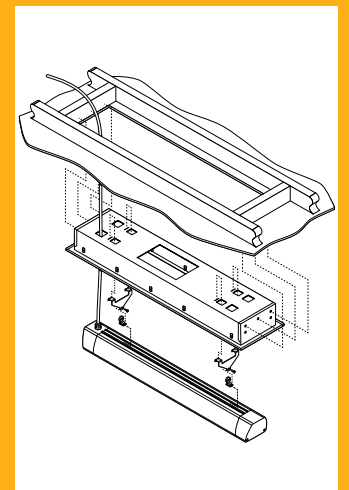



## HEATSTRIP® INTENSE

WITH REMOTE & APP

This sleek, white electric heating system provides a modern and attractive outdoor heating solution with high output and instant heat. Perfect for undercover and semi-exposed outdoor areas or indoor use, you can control it with an app or remote for added convenience.

- Indoor/outdoor electric radiant heater.
- 2 models available X-THB2200WA (2200W) & X-THB3200WA (3200W).
- Remote, APP plus smart home connectivity. Compatible with Google and Amazon smart home platforms. Bluetooth & WIFI.
- Standard mounting bracket can be used for wall or ceiling mounting. Bracket can also be used to suspend the heater using chains or wires.
- Ideal Mounting Height: 2.1 – 2.5m, 7-8ft.
- Max mounting height 2.7m, 9ft.
- 3-year residential and 1-year commercial warranty.

### Remote & App



App and remote control provides 3 heat levels with adjustable timer options from 0-24 hours with the touch of a button

### Optional mounting accessories



Flush Mount Enclosure is an ideal way to neatly install the Heater into a ceiling.



Extension Mount Poles allow units to be lowered from high ceilings.



Standard Mounting Bracket ZBRAK-132W included with the heater.



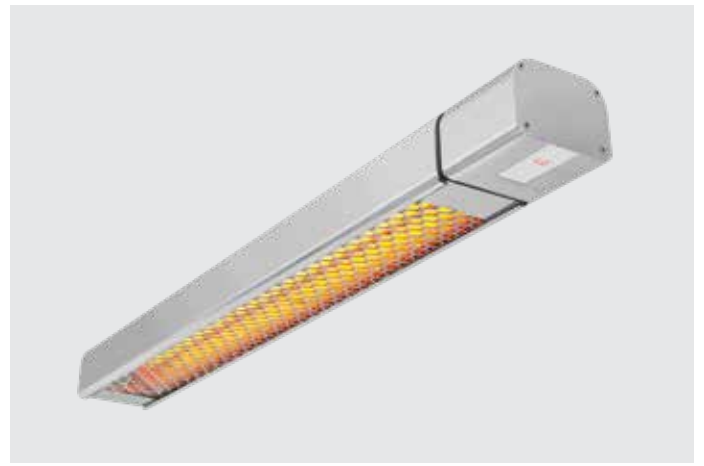

## Specifications

Model	Voltage (V)	Power (Watts)	Current (Amps)	Dimensions	Weight	Gang Box	Heating Area	Standard Bracket	Flush Mount Kit	Extension Poles
X-THB2200WA	240	2200	9.2	900x122x90mm 35.4x4.8x3.5in	6kg 13lb	Yes	5-9 m <sup>2</sup> 54-97ft <sup>2</sup>	ZBRAK-132W	THBAC-001	THEAC-043 (300mm 11.8in) THEAC-044 (600mm 23.6in) THEAC-045 (900mm 35.4in) THEAC-046 (1200mm 47.2in)
X-THB3200WA	240	3200	13.3	1040x122x90mm 41x4.8x3.5in	7kg 15lb	Yes	8-13 m <sup>2</sup> 86-140ft <sup>2</sup>	ZBRAK-132W	THYAC-051	

## Coverage

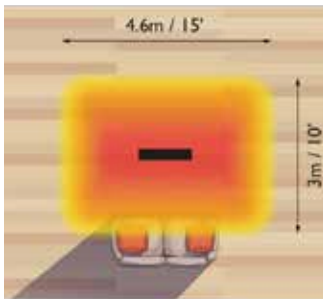

X-THB2200WA  
Indoor protected

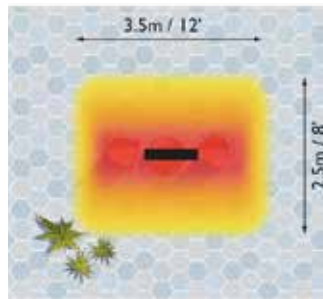

X-THB2200WA  
Outdoor enclosed

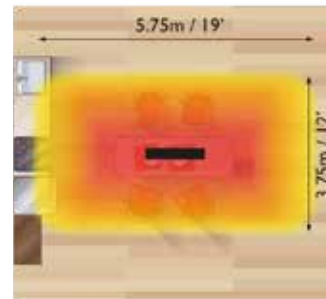

X-THB3200WA  
Indoor protected

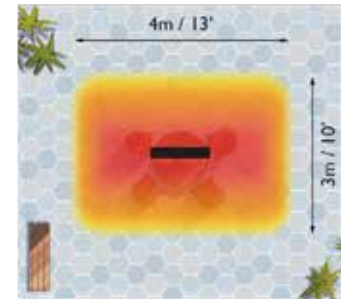

X-THB3200WA  
Outdoor enclosed

## Mounting options



## Flush mount detail

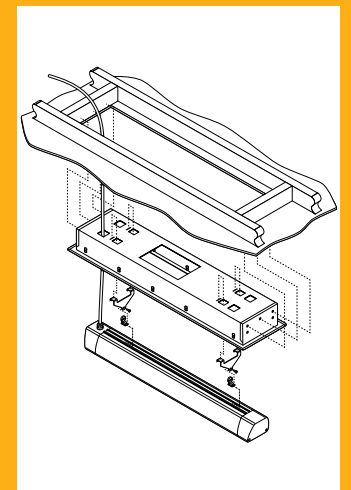



# HEATSTRIP®

## WALL MOUNTED GAS

The new and upgraded HEATSTRIP® Wall Mounted Gas heaters are a stylish addition to any outdoor area. World-class design aesthetics, heat output and performance, for both residential and commercial applications.

- 34 MJ, 4 tile commercial quality ceramic burner
- X-DGR32WNG (Natural Gas Model)
- Electronic finger pull ignition and flame failure device
- World-class wind protection rating at 16 km / 10 m an hour
- Protective grille and reflector included as standard, to guarantee safe operation
- Reflector design ensures that only a minimum of 500mm / 1.6ft overhead clearance is required. Optional accessories for low clearance or ceiling
- Wall mounting bracket allows for multiple mounting angles

### Controls



Electronic finger pull ignition and extinguish

### Optional mounting accessories



X-DGRSHIELD. Heat shield



X-DGRPOLE-WM. Ceiling mount extension pole

For the standard heat reflector supplied with the heater, a 1.6ft / 500mm overhead clearance is required. For low clearance mounting, please use the optional heat shield (X-DGRSHIELD) which provides for a 1ft / 300mm overhead clearance.

For high ceilings or mounting flexibility, the optional ceiling mount extension pole (X-DGRPOLE-WM) can be used to reduce the height of the heater by 1.6ft / 500mm or for mounting from the ceiling when a wall is not available.

**Materials of Construction:** (Head) Stainless steel (420ss) with high temperature paint coating.



## Specifications

Model	Tiles	MJ	Dimensions	Weight	Ignition	Heating Area	Gas Type
X-DGR32WNG	4	34	650x190x380mm 23.6x7.5x15in	11.5kg 25lb	Electronic finger pull	16 m <sup>2</sup> 172ft <sup>2</sup>	Natural Gas

## Radiant Footprint

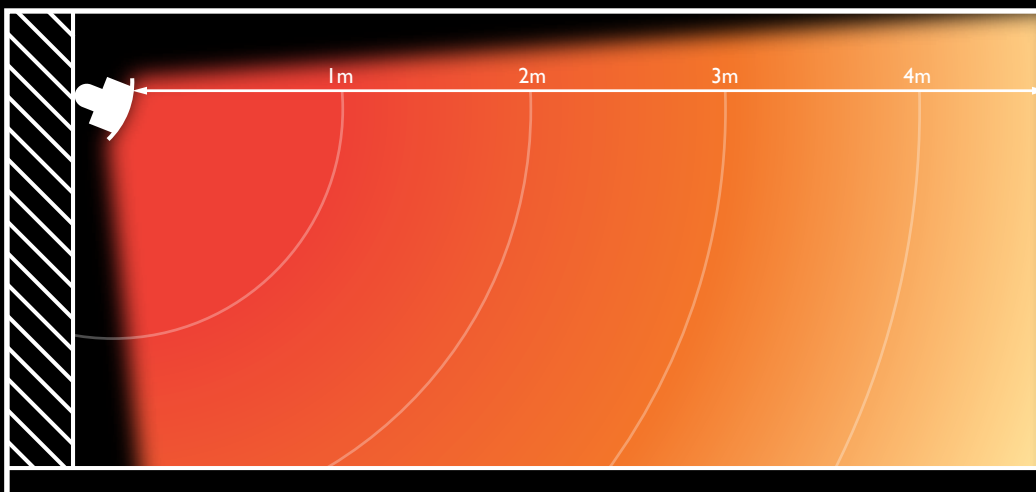

## Mounting height

Minimum recommended mounting height: 6.5ft / 2.0m

Maximum mounting height: 11.5ft / 3.5m outdoors

The diagram to the left illustrates the radiant footprint of 16ft / 5m.



# HEATSTRIP®

## PORTABLE LPG

The new HEATSTRIP® Portable LPG heater incorporates world-leading design, quality, heat performance and efficiency to provide a stylish, robust and elegant solution for your outdoor area, alfresco, balcony, patio etc.

- 34 MJ, 4 tile commercial quality ceramic burner to be used with a 9kg / 20lb LPG bottle (not included)
- X-DGR32PLP-HEAD & X-DGR32PLP-STAND
- NEW electronic finger pull ignition, with tilt safety switch and flame failure device. Fully concealed gas pipes and bottle
- In-built wheels for easy portability and storage
- World class wind protection rating at 16 km / 10m per hr
- Protective grille and reflector included as standard, to guarantee safe operation
- Suitable for residential and commercial applications

### Controls



Electronic finger pull ignition and extinguish

### Optional mounting accessories



X-DGRSHIELD. Heat shield



X-TGHCOVER. Protective cover for X-DGR32PLP-HEAD and stand unit.

For the standard heat reflector supplied with the heater, a 500mm / 1.6ft overhead clearance is required. For low clearance mounting, please use the optional Heatshield (X-DGRSHIELD) to allow a 300mm / 1ft overhead clearance.





## Specifications

Model	Tiles	MJ	Dimensions	Weight	Ignition	Heating Area	Gas Type
X-DGR32PLP-HEAD X-DGR32PLP-STAND	4	34	650x670x2118mm 23.6x26.4x83.4in	31.5kg 69lb	Electronic finger pull	16 m <sup>2</sup> 172ft <sup>2</sup>	LPG

## Radiant Footprint

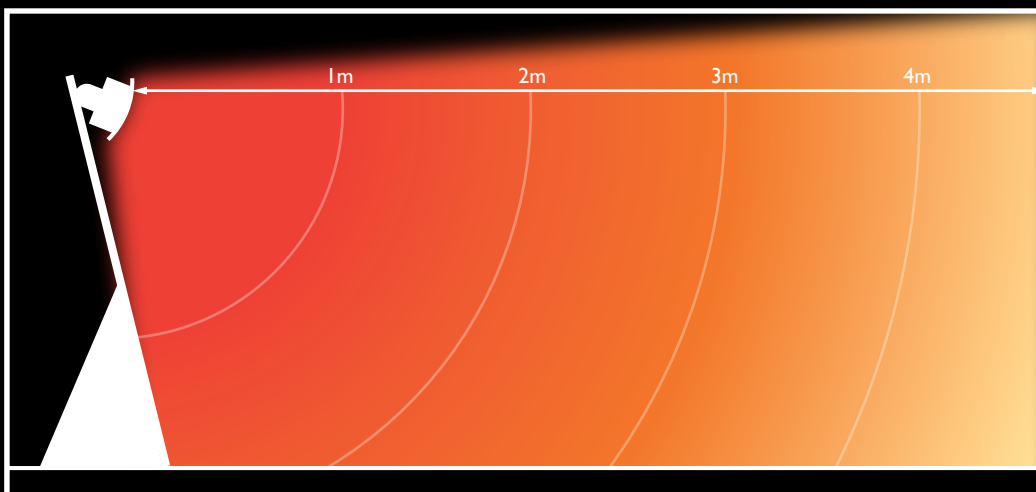

## Positioning

The HEATSTRIP Portable LPG heater (X-DGR32PLP) has been designed for a 9kg / 20lb LPG bottle as standard. However the design can also accommodate a wide range of commercial and industrial grade LPG bottles that can extend the operating hours of the heater. Suitable sizes that the heater can accommodate are up to 45kg / 100lb with the addition of a conversion kit.

The diagram to the left illustrates the radiant footprint of 5m / 16ft.

---

**HEATSTRIP**<sup>®</sup> 

US-V10/24

AMD Direct Inc.  
14520 Delta Lane, Ste 105  
Huntington Beach, CA 92647  
Phone: 800-966-8126  
Email: [Heatstrip@amddirect.com](mailto:Heatstrip@amddirect.com)  
[www.heatstrip.com](http://www.heatstrip.com)